

# CHA

ABOVE CEILING

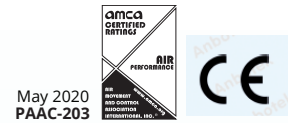

The CHA unheated air curtain has been tested in accordance with ANSI/AMCA 220 and meets the criteria for use as an exception to the vestibule requirement in Climate Zones 3 and above. It is specifically designed to be dropped into the ceiling above customer entryways where a standard air curtain is not desired.

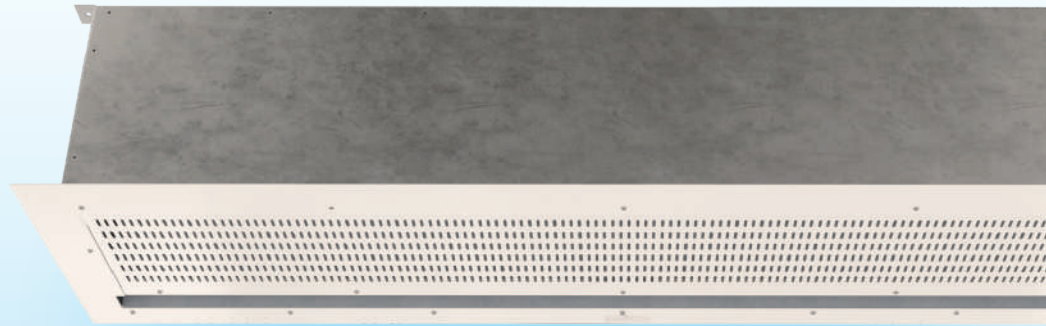

## AT A GLANCE

Single Incremental Widths

3' to 12'

Max Installation Height

14'

Heavy Duty Motors

3/4 HP

### KEY DESIGN FEATURES

- Galvanized steel case.
- Heavy duty 3/4 HP motors. 1630 rpm each.
- High efficiency discharge plenum ensures that air being discharged fills the entire width and height of the opening. This also lowers the operational sound level.
- White powder coated decorative intake grille.
- Directional air foil vane factory set to facilitate deflection of air stream +/- 20 degrees.

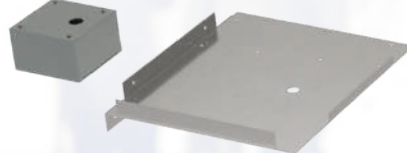

### RECOMMENDED CONTROLS

- ON / OFF switch
- Magnetic door switch for activation
- Time delay relay



## ► CHA | PERFORMANCE

### CHA | Performance Table

MODEL	Nozzle Width (in.)	Average Outlet Velocity (FPM)	Air Flow Rate (CFM)	Outlet Velocity Uniformity	Power Rating (kW)	Number of Motors	Motor HP	Weight (lbs)
CHA-1-36	36	2987	1374	91%	0.68	1	3/4	179
CHA-1-48	48	2674	1765	91%	0.84	1	3/4	195
CHA-1-60	60	2396	1845	73%	0.87	1	3/4	225
CHA-2-72	72	2987	2748	91%	1.36	2	3/4	358
CHA-2-84	84	2808	3139	91%	1.52	2	3/4	371
CHA-2-96	96	2674	3530	91%	1.68	2	3/4	384
CHA-2-108	108	2520	3610	73%	1.71	3	3/4	397
CHA-3-108	108	2987	4122	91%	2.04	3	3/4	537
CHA-3-120	120	2862	4513	73%	2.2	3	3/4	550
CHA-3-132	132	2759	4904	91%	2.36	3	3/4	563
CHA-4-144	144	2987	5496	91%	2.52	4	3/4	716

**!** For a unit over 12 feet long, consult factory.

Performance data shown above is for 60 Hz power supply. For 50Hz, 17% reduction in performance data.

### CHA | Velocity Projection Model

DISTANCE FROM NOZZLE	40"	80"	120"	160"	200"
CHA-1-36 Core Velocity (fpm)	1500	1053	839	722	536
CHA-1-48 Core Velocity (fpm)	1388	908	715	602	556
CHA-1-60 Core Velocity (fpm)	1217	770	603	523	467

### CHA | Sound Levels

Normal speed      63 dBA      Measured 10 ft. from unit in a free field based on a 1 motor unit

### CHA | Single Phase Motor Options

Voltages available	120	208/230	480	575	For dual speed motors, consult factory. For three phase motors, consult factory
Amp draw per motor	8.0	3.6	2.0	1.5	



### Performance Highlight

Perfect for customer facing spaces in retail environments, the model CED positions the blowers pointing toward the back of the air curtain. Here they fill a specially designed plenum that when pressurized is more efficient and lowers the operational sound level.

The AMCA Certified Ratings Seal applies to airflow rate, average outlet velocity, outlet velocity uniformity, velocity projection and power rating at free delivery only. Rated data shown are based on tests of units with heating elements present but not in use.

Powered Aire Inc. certifies that the Model CHA Air Curtain shown herein is licensed to bear the AMCA Seal for Air Performance. The ratings shown are based on tests and procedures performed in accordance with AMCA Publication 211 and comply with the requirements of the AMCA Certified Ratings Program.

May 2020  
PAAC-203



# ► CHA & CHA-E | MECHANICAL DETAILS & DRAWINGS

CHA & CHA-E | Mechanical Information Table

MODEL	Overall Width (in.)	Nozzle Width (in.)	Mounting Width (in.)
CHA-1-36 (E)	39	36	37.5
CHA-1-48 (E)	51	48	49.5
CHA-1-60 (E)	63	60	61.5
CHA-2-72 (E)	75.07	72.07	73.57
CHA-2-84 (E)	87.07	84.07	85.57
CHA-2-96 (E)	99.07	96.07	97.57
CHA-2-108 (E)	111.07	108.07	109.57
CHA-3-108 (E)	111.15	108.15	109.65
CHA-3-120 (E)	123.15	120.15	121.65
CHA-3-132 (E)	135.15	132.15	133.65
CHA-4-144 (E)	147.22	144.22	145.72

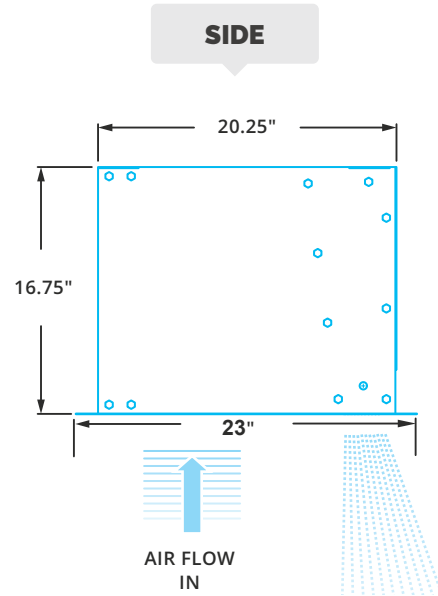

TOP

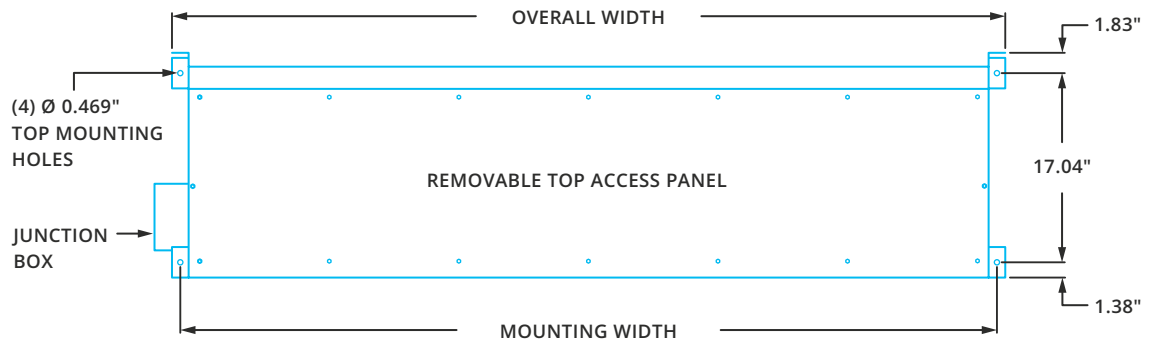

FRONT



BOTTOM

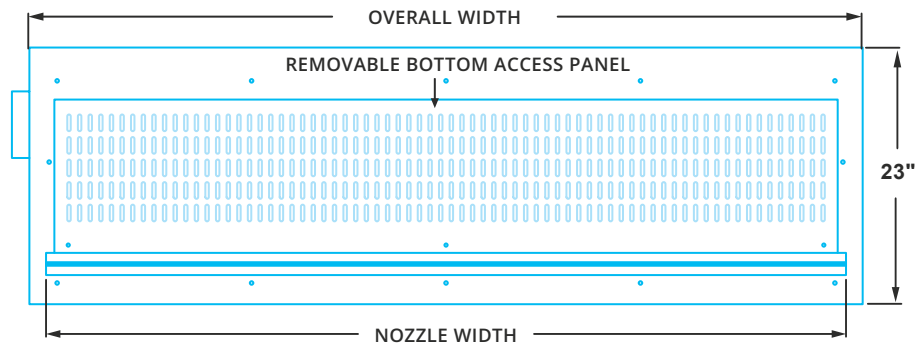



## ► **CHA, CHA-E, CHA-HW/ST | INSTALLATION**

### **!** IMPORTANT

- ✓ Trained and experienced mechanic / electrician required.
- ✓ **WARNING:**  
Risk of electrical shock, can cause injury or death: Disconnect all remote electrical supplies before servicing.
- ✓ Units must be field wired in accordance with all applicable local, state, provincial and national codes, including wire size and materials.

### **✍** NOTE

For every one inch the bottom of the air curtain is mounted above the door header, the back side of the air curtain should be moved away from the wall ½ inch.

Unit has four 15/32 inch holes for installing one end of 7/16" threaded rods. The other ends of the threaded rods can be attached to the ceiling. Washers and lock washers or locknuts are recommended. Mounting structure should be of sufficient strength to hold air curtain, and hardware (supplied by others) should be of sufficient strength and quality to support the unit safely.



#### **STEP 1**

Remove intake/discharge grille from bottom of air curtain. If ceiling is already in place, determine where air curtain location will be and cut a rectangular hole in the ceiling. The hole will be 1 inch longer and wider than the bottom length and width of the air curtain without the intake/discharge grille.

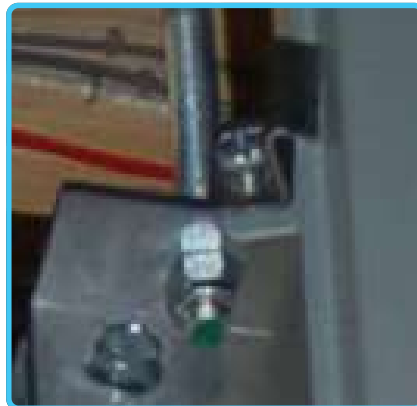

#### **STEP 2**

Suspend air curtain using threaded rods so that the bottom of the unit is centered within the cut out in the ceiling. There will be a 1/2 inch gap around the air curtain. Mount the unit so that the bottom is flush with the ceiling.



#### **STEP 3**

Attach the intake/discharge grille to the bottom of the air curtain. The grille is larger than the air curtain to cover the gaps between the air curtain and ceiling.

### **CLERANCE**

**Minimum 3" clearance required on back**

**Minimum 30" clearance required in front**

**Minimum 6" clearance required on bottom**  
(Discharge cannot be blocked)

